

## floor drain body type 61 HT DallBit PP NIRO, DN 70

Part number: 612847  
 GTIN: 4001636612847  
 Rebate group: 3

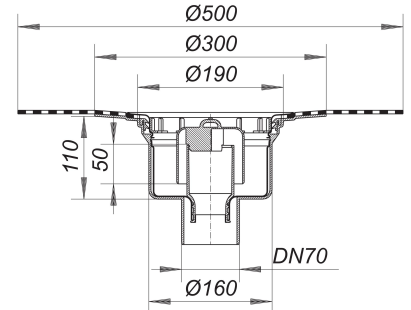

### Description:

floor drain body type 61 HT DallBit PP NIRO, DN 70  
 conforming to DIN EN 1253

With d: 500 mm collar of 5.0 mm thick bituminous membrane, welded to the flange and secured with stainless steel clamp ring.  
 outlet vertical spigot, for connection to plastic pipework

#### specification

- stainless steel liner
- removable trap insert, 50 mm water seal (conforming to DIN EN 1253)
- temporary blanking plate

#### material

polypropylene,  
 304 stainless steel

DN 70 connects to BS4514 75 mm pipework with 880345 adaptor.

Drainage with increased hygienic requirements, eg. commercial kitchens, hospitals, food processing, etc.

R 30/60/90/120 options see page XXX.

### Flow rates tested to DIN EN 1253:

Nominal diameter	Product standard	Min. flow rate according to norm	Water level according to norm
DN 70	DIN EN 1253	0.80 l/s	20.00 mm

### Spare parts:

590077 bell trap for drain body 61